



 **PERFIL**
MASTER
DIVISÃO ENERGIA SOLAR

Conheça nossos produtos



Suporte Z

Código: ES 0001



Fixador Final

Código: ES 0002



Fixador Central

Código: ES 0003



Perfil H

Código: ES 0004 (4400 M)

Código: ES 0010 (4800 M)

Código: ES 0011 (2400 M)

Código: ES 0019 (2200 M)



Parafuso rosca dupla

Código: ES 0008 metal

Código: ES 0009 madeira



Suporte S

Código: ES 0015



Fixador Cental U

Código: ES 0016



Fixador com Regulagem

Código: ES 0017

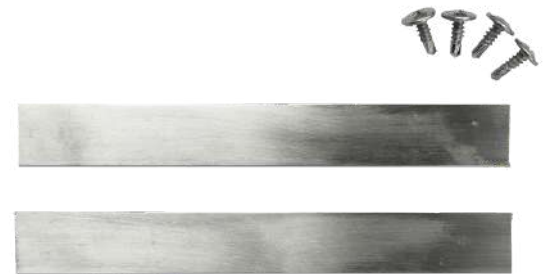

Junção Perfil H

Código: ES 0018



KIT de fixação Mini Trilho

Código: ES 0022

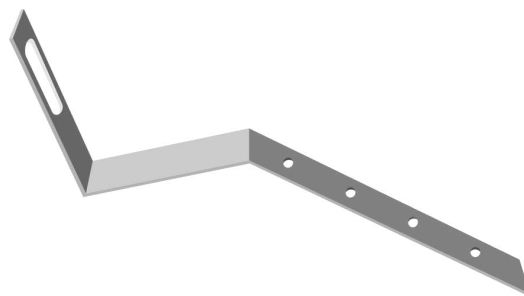

Suporte para Telhado Kalhetão

Código: ES 0026



WWW.PERFILMASTER.COM.BR



11 91483-4040



11 4823-7008



divisao.solar@perfilmaster.com.br



[enrgiasolar.perfilmaster](https://www.facebook.com/enrgiasolar.perfilmaster)

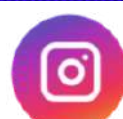

[perfil_master_des](https://www.instagram.com/perfil_master_des)

Padrão de Embalagem

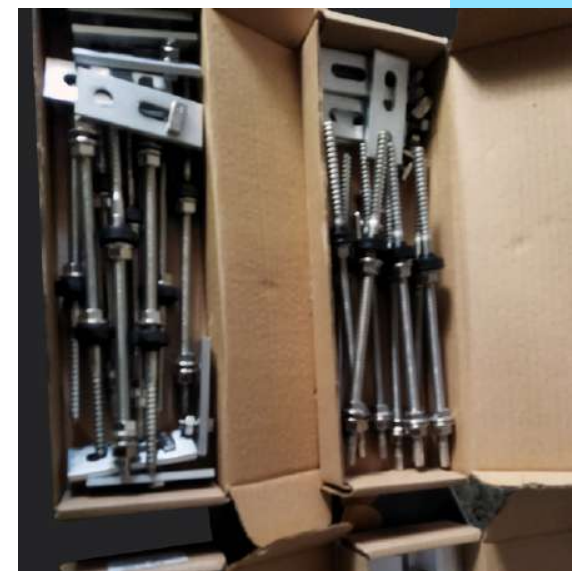

Pensando na praticidade e qualidade de nossos produtos.

Utilizamos o Padrão de Embalagem onde todas as peças são embaladas e identificadas em caixas individuais sempre em múltiplos, facilitando a logística interna do cliente e a expedição.

Os fixadores Fibrocimento, Madeira, Metal, Suporte “Z” e “S” em caixas com 8 unidades.

Os Clamps Centrais, caixas com 6 unidades e os Clamps Finais caixas com 4 unidades.



A PERFILMASTER está no mercado desde 2014, integrando um grupo de empresas que atua no segmento da construção civil há 50 anos.



Especializada no ciclo de produção de perfis de alumínio da extrusão ao acabamento, para diversos segmentos do mercado.

Iniciando em 2021 no segmento de ENERGIA SOLAR com perfis e fixadores para MÓDULOS FOTOVOLTAICOS.

Além da extrusão de perfis a PERFILMASTER atua no tratamento de superfície dos mesmos com PINTURA ELETROSTÁTICA.

NOSSA POLÍTICA DE QUALIDADE:

Fabricar produtos com a melhor relação custo/benefício, com eficiência e em conformidade com os procedimentos, normas técnicas e socioambientais. Cumprir os requisitos negociados, com objetivo de garantir a satisfação dos nossos clientes.

Extrusora



Pintura Eletrostática



PRODUTOS EM ALUMÍNIO/AÇO INOXIDÁVEL.



Alta durabilidade
Fácil instalação e ajuste

O alumínio apresenta alta performance e propriedades mecânicas que garantem a segurança em sua aplicação, respeitando as normas vigentes para o segmento. Sua composição química apresenta versatilidade, resistência à corrosão, durabilidade e reciclabilidade.

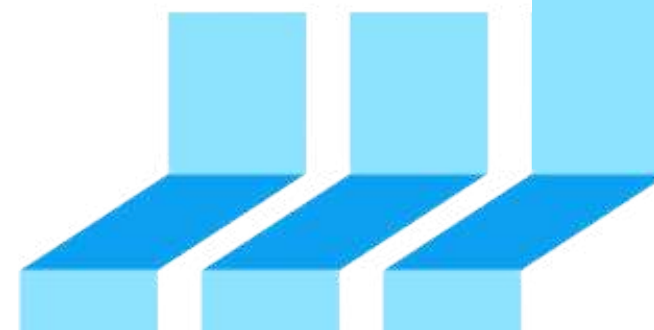



Kit fixação Telha colonial

Código: ES 0005

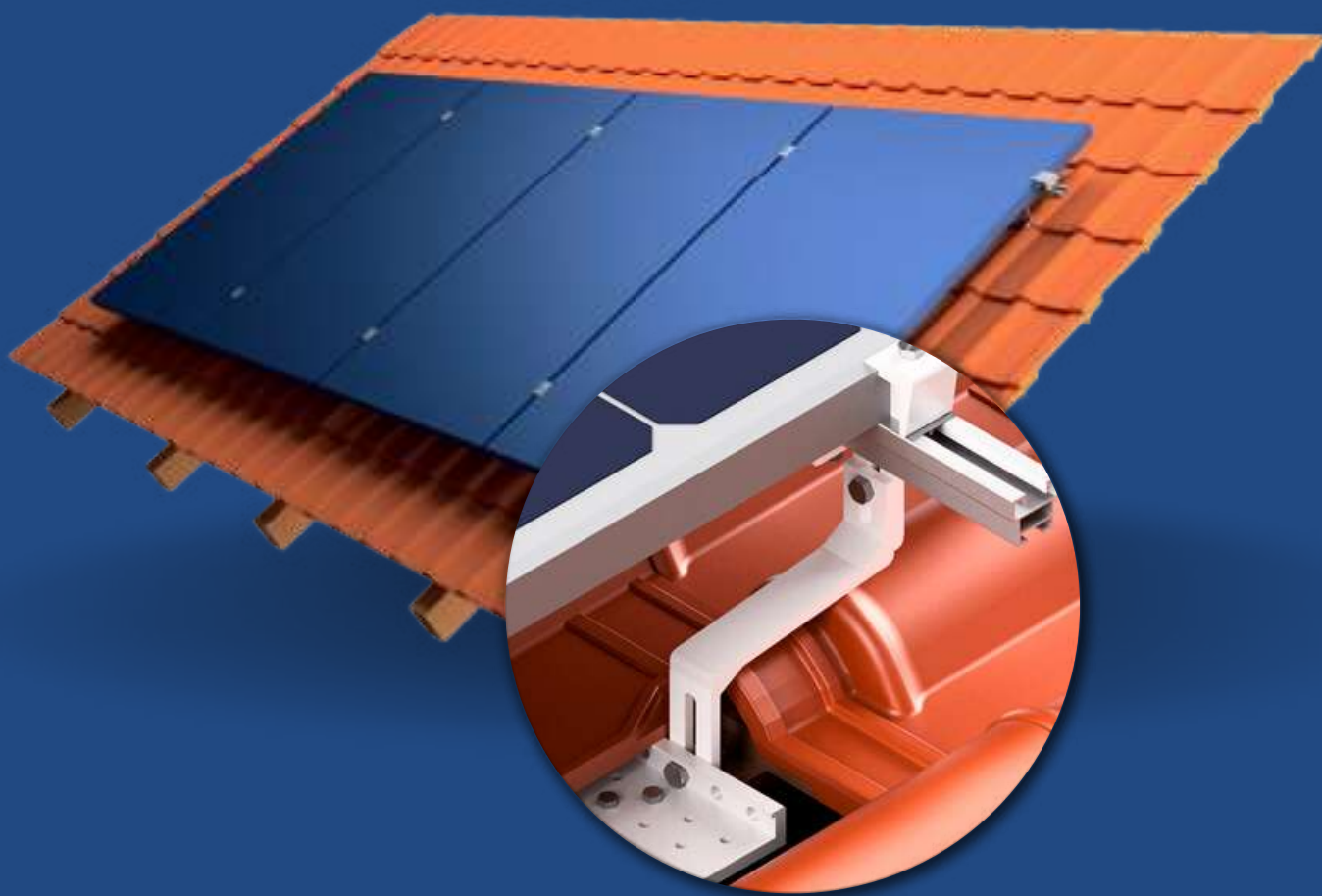

Composição Kit fixação Telha colonial



Suporte Z

8 Unidades

Possui ajustes de altura.



Perfil H

2 Unidades

Disponível nos tamanhos

- 2,2 Metros
- 2,4 Metros
- 4,4 Metros
- 4,8 Metros



Fixador central

6 Unidades



Fixador Final

4 Unidades

Ficha técnica ES 0005 -



Suporte Z



ARRUELA DE PRESSÃO M8 DIN 127 INOX

24 peças



PORCA SEXT M8 DIN 934 INOX

24 peças



PARAFUSO T M8X20 INOX

08 peças



PARAFUSO FRANCÊS M8 X 20 DIN 603

16 peças



PARAFUSO SEXTAVADO ROSCA SOBERBA M6 X 50MM

24 peças



Fixador Final



PARAFUSO CIL SX INT M6 X 40 DIN 912 INOX

04 peças



PORCA QUADRADA M6 DIN 557 INOX

04 peças



ARRUELA DE PRESSÃO M6 DIN 127 INOX

04 peças



Fixador Central



PARAFUSO CIL SX INT M6 X 40 DIN 912 INOX

06 peças



PORCA QUADRADA M6 DIN 557 INOX

06 peças



ARRUELA DE PRESSÃO M6 DIN 127 INOX

06 peças



Kit fixação telha fibrocimento
e metálica - Viga metálica

Código: ES 0006

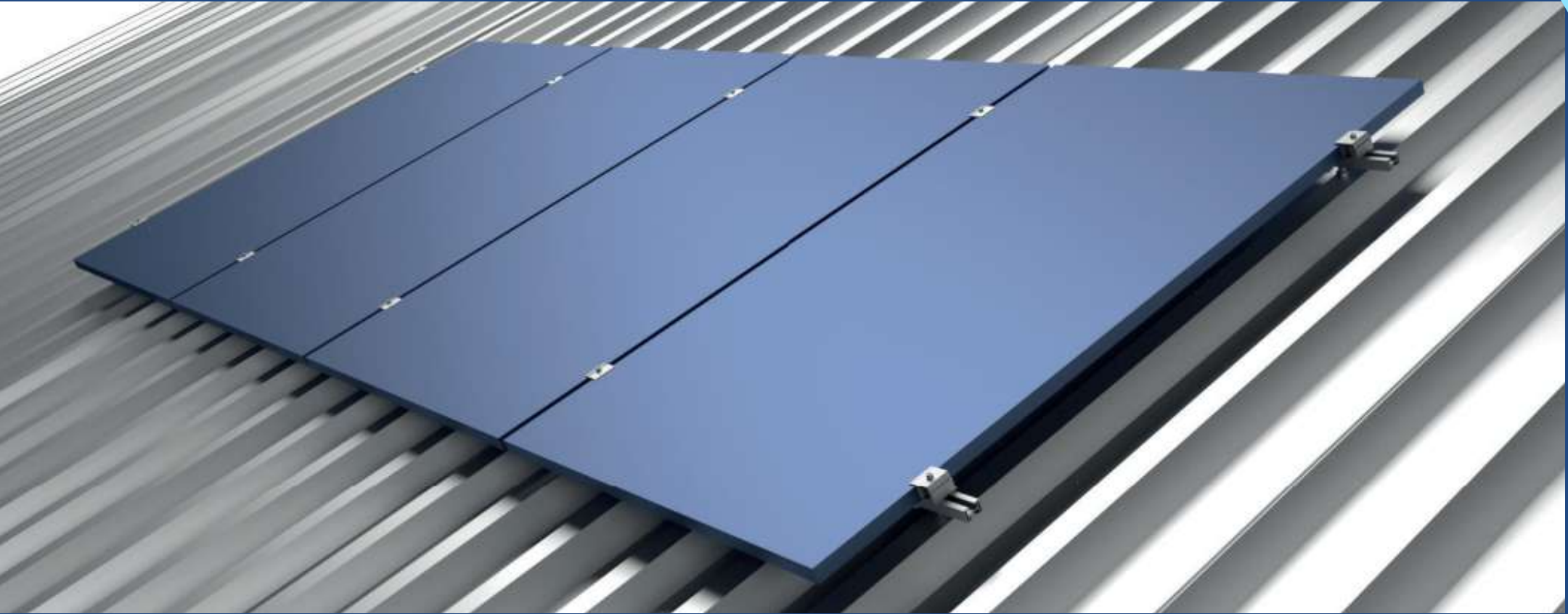

Composição Kit fixação telha fibrocimento e metálica - Viga metálica



Parafuso rosca dupla

8 Unidades

Parafuso rosca dupla 250 milímetros de comprimento em inox, com base de alumínio.



Perfil H

2 Unidades

Disponível nos tamanhos

- 2,2 metros
- 2,4 Metros
- 4,4 Metros
- 4,8 Metros



Fixador central

6 Unidades



Fixador Final

4 Unidades

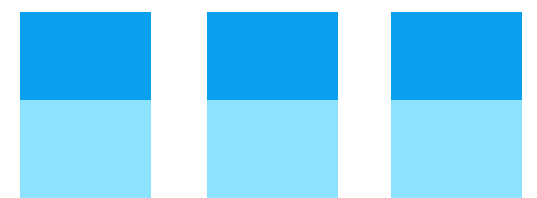

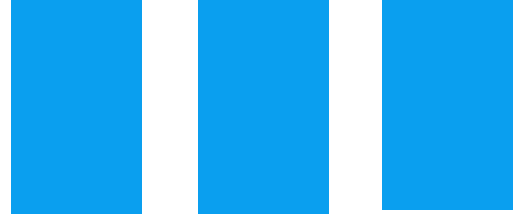

Parafuso rosca dupla



ARRUELA DE PRESSÃO M8 DIN 127 INOX

08 peças



PORCA SEXT M8 DIN 934 INOX

08 peças



PARAFUSO T M8X20 INOX

08 peças



PORCA FLANGEADA M8 INOX

24 peças



ARRUELA DE VEDAÇÃO EDMP M10

08 peças



BASE DE ALUMÍNIO - 31,50MM X 80MM X 5MM

08 peças



Fixador Final



PARAFUSO CIL SX INT M6 X 40 DIN 912 INOX

04 peças



PORCA QUADRADA M6 DIN 557 INOX

04 peças



ARRUELA DE PRESSÃO M6 DIN 127 INOX

04 peças



Fixador Central



PARAFUSO CIL SX INT M6 X 40 DIN 912 INOX

06 peças



PORCA QUADRADA M6 DIN 557 INOX

06 peças



ARRUELA DE PRESSÃO M6 DIN 127 INOX

06 peças

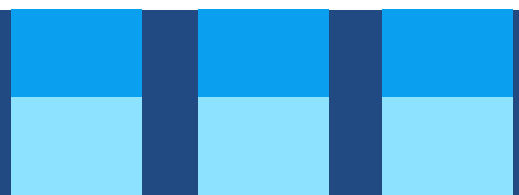



Kit fixação telha
fibrocimento e metálica -
Viga madeira

Código: ES 0007

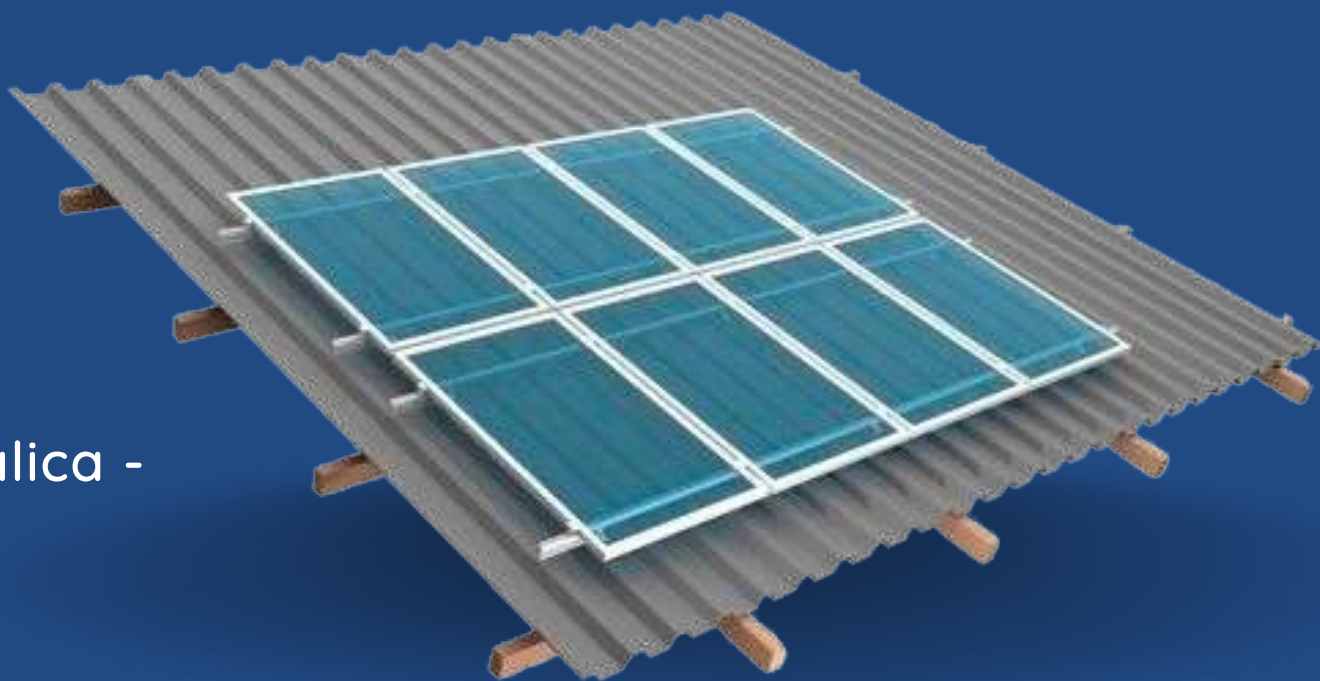

Composição Kit fixação telha fibrocimento e metálica - Viga madeira



Parafuso rosca dupla

8 Unidades

Parafuso rosca dupla 250 milímetros de comprimento em inox, com base de alumínio.



Perfil H

2 Unidades

Disponível nos tamanhos

- 2,2 metros
- 2,4 Metros
- 4,4 Metros
- 4,8 Metros



Fixador central

6 Unidades



Fixador Final

4 Unidades

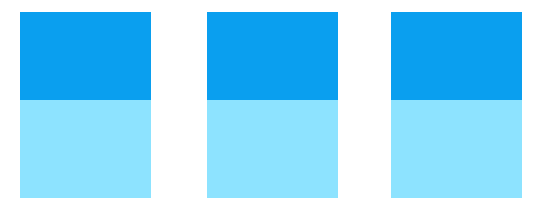

Ficha técnica ES 0007 -

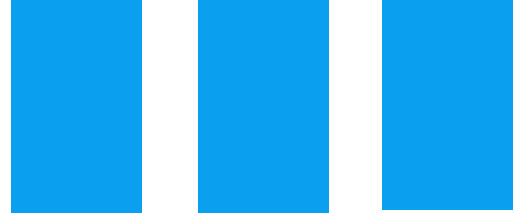

Parafuso rosca dupla



ARRUELA DE PRESSÃO M8 DIN 127 INOX

08 peças



PORCA SEXT M8 DIN 934 INOX

08 peças



PARAFUSO T M8X20 INOX

08 peças



PORCA FLANGEADA M8 INOX

24 peças



ARRUELA DE VEDAÇÃO EDMP M10

08 peças



BASE DE ALUMÍNIO - 31,50MM X 80MM X 5MM

08 peças



Fixador Final



PARAFUSO CIL SX INT M6 X 40 DIN 912 INOX

04 peças



PORCA QUADRADA M6 DIN 557 INOX

04 peças



ARRUELA DE PRESSÃO M6 DIN 127 INOX

04 peças



Fixador Central



PARAFUSO CIL SX INT M6 X 40 DIN 912 INOX

06 peças



PORCA QUADRADA M6 DIN 557 INOX

06 peças



ARRUELA DE PRESSÃO M6 DIN 127 INOX

06 peças

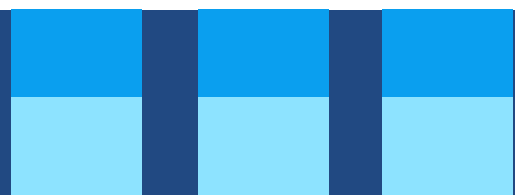

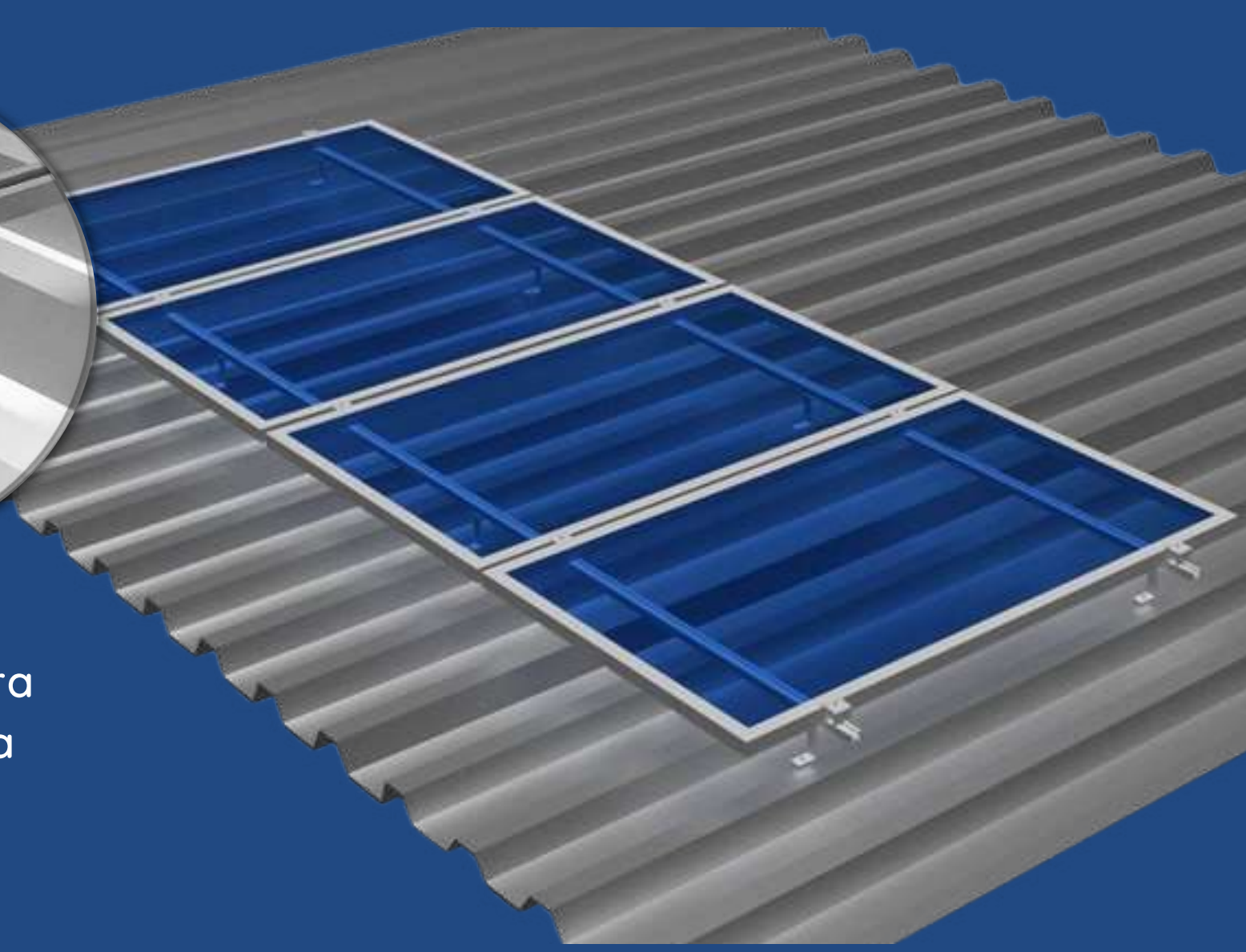
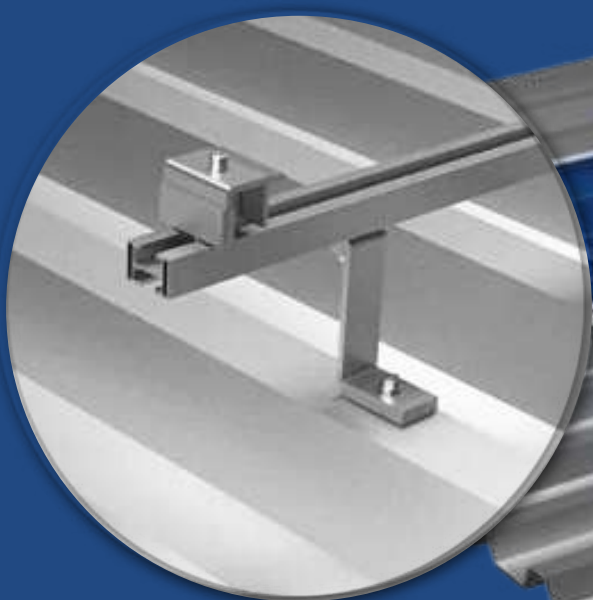

Kit fixação para
telha ondulada

Código: ES 00014

Composição Kit fixação telha fibrocimento e metálica - Viga madeira



Suporte S

8 Unidades



Perfil H

2 Unidades

Disponível nos tamanhos

- 2,2 Metros
- 2,4 Metros
- 4,4 Metros
- 4,8 Metros



Fixador central

6 Unidades



Fixador Final

4 Unidades

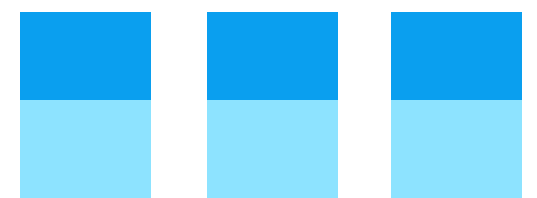

Fixa técnica ES 0007 -



Suporte S



ARRUELA DE PRESSÃO M8 DIN 127 INOX

08 peças



PORCA SEXT M8 DIN 934 INOX

08 peças



PARAFUSO T M8X20 INOX

08 peças



ARRUELA DE VEDAÇÃO EDMP M5

08 peças



BORRACHA DE VEDAÇÃO EDMP

08 peças



PARAFUSO INOX M5 X 100MM

08 peças



Fixador Final



PARAFUSO CIL SX INT M6 X 40 DIN 912 INOX

04 peças



PORCA QUADRADA M6 DIN 557 INOX

04 peças



ARRUELA DE PRESSÃO M6 DIN 127 INOX

04 peças



Fixador Central



PARAFUSO CIL SX INT M6 X 40 DIN 912 INOX

06 peças



PORCA QUADRADA M6 DIN 557 INOX

06 peças



ARRUELA DE PRESSÃO M6 DIN 127 INOX

06 peças

Composição Kit fixação Mini Trilho ES 0022



Mini Trilho Alto

1 Unidade 100mm (altura) x 550mm (comprimento)



PARAFUSO SEXT. BROCANTE FLANGEADO 5.5X50

06 PEÇAS



BORRACHA DE VEDAÇÃO

06 PEÇAS

Itens necessários, adquiridos separadamente de acordo com o projeto a ser executado



Fixador central



Fixador Final

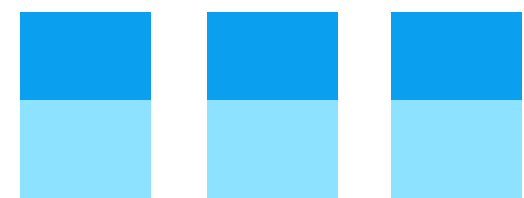

Composição Kit Suporte Kalhetão ES 0026

PARAFUSO CIL SX INT M6 X 40 DIN 912 INOX

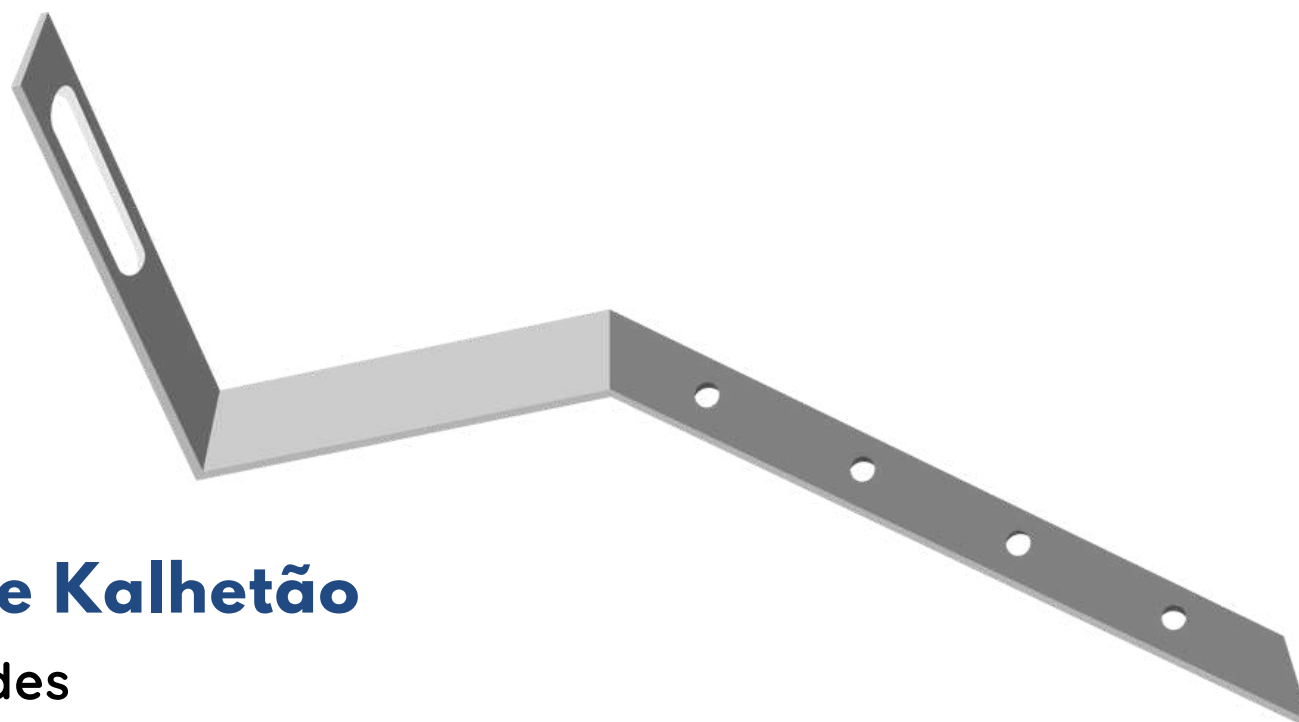

Suporte Kalhetão

8 Unidades



PARAFUSO T M8 X 20 INOX

08 peças



ARRUELAS DE PRESSÃO INOX M8

08 peças



PORCAS SEXTAVADAS M8 INOX

08 peças

**Itens necessários, adquiridos separadamente de
acordo com o projeto a ser executado**



Perfil H



**Fixador
central**



**Fixador
Final**

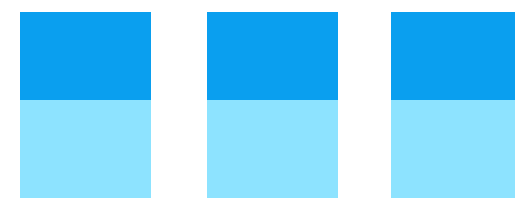



**Suporte de
solo para
4 módulos**



**Suporte de
solo para
8módulos**



**Itens necessários, adquiridos separadamente de
acordo com o projeto a ser executado**



**Fixador
central**



**Fixador
Final**



Suporte de laje em alumínio para 4 módulos



**Itens necessários, adquiridos separadamente de
acordo com o projeto a ser executado**



Perfil H



**Fixador
central**



**Fixador
Final**

Carport kit para 15 modulos

Código: ES 0028
5.900mm X 6.900mm

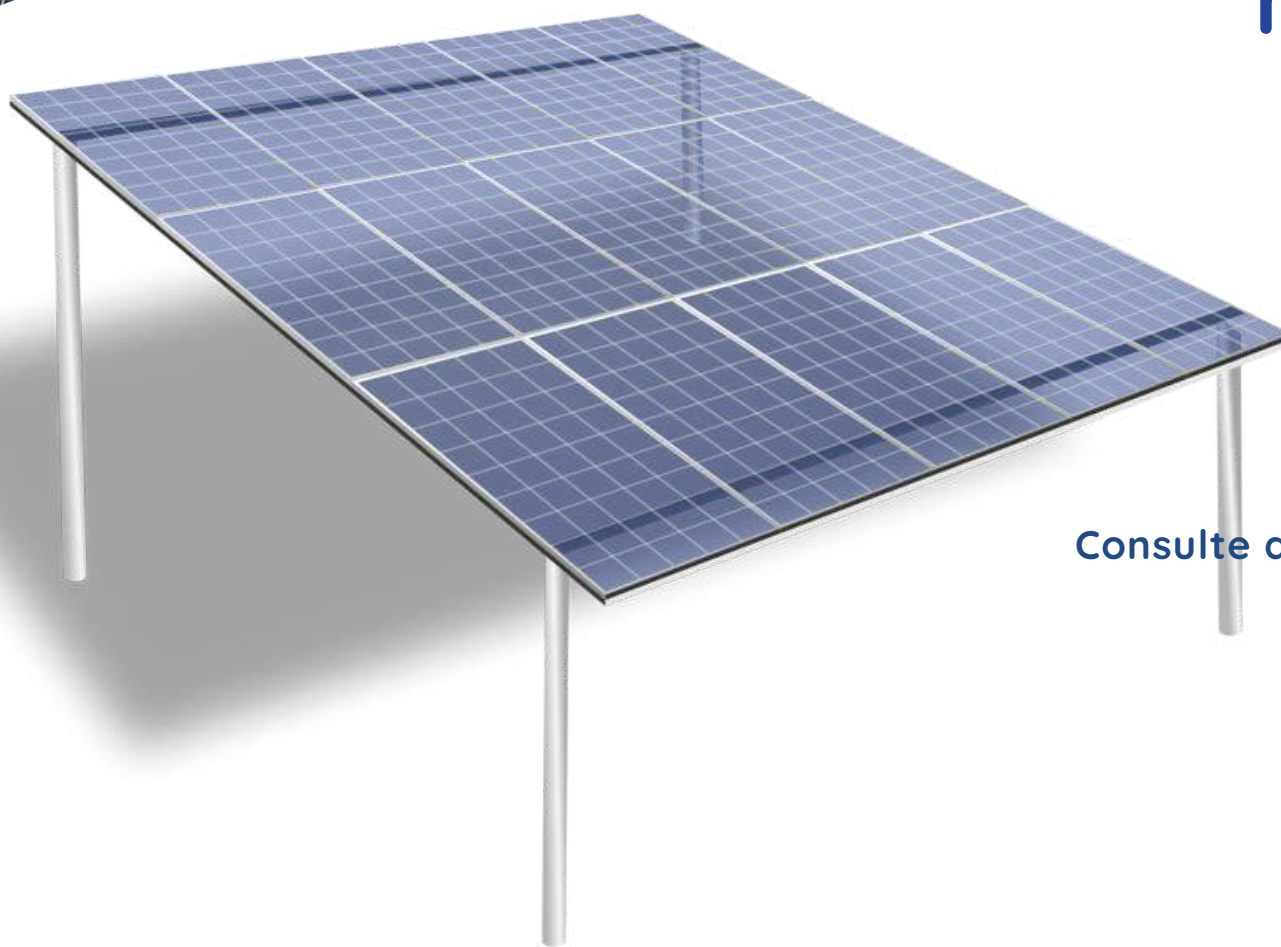

Consulte disponibilidade

Itens necessários, adquiridos separadamente de acordo com o projeto a ser executado



Fixador central



Fixador Final



WWW.PERFILMASTER.COM.BR



11 91483-4040



11 4823-7008



divisao.solar@perfilmaster.com.br



Rua Manoel Simões, 156 Roncon Ribeirão Pires- Sp, 09411-110

 **enrgiasolar.perfilmaster**

 **perfil_master_des**