

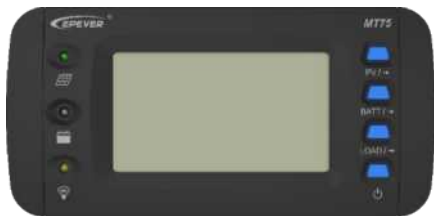

Remote Meter

USER MANUAL



MT75

Contents

1. Safety Instructions	1
2. Overview	2
3. Appearance	3
4. Accessories	4
5. Installation Instructions	5
6. Indicator Instruction	7
7. Button Instruction.....	8
8. LCD Display	9
9. Error Codes.....	11
10. Specifications	13
11. Dimension	15
12. Recommended Applications.....	16
12.1 Standard Application.....	16
12.2 Upgrade Application	17
12.3 Advanced Application	18
12.4 Pro. Application	20

1. Safety Instructions

- Please keep this manual for future reference.
- Please read this manual and safety information carefully before using the product.
- Keep the product away from rain, exposure, severe dust, vibration, corrosion, and intense electromagnetic interference.
- Please avoid water, and other liquids enter into the product.
- There are no user serviceable parts inside the product. Do not disassemble or attempt to repair it.

2. Overview

MT75 is a new generation of remote meter which can monitor the EPEVER solar charge controller and inverter on one screen at the same time. This product provides multiple solutions to fit different requirements from off-grid users.

Features:

- Dual RJ45 communication ports
- 4.7-inch LCD screen, real-time dynamic display of system data
- Visually error codes, timely notification of warnings and faults
- Load ON/OFF button to control the load output directly
- Dry contact output and enable switch design
- Remote control inverter ON or OFF
- Friendly connect with different EPEVER devices

3. Appearance

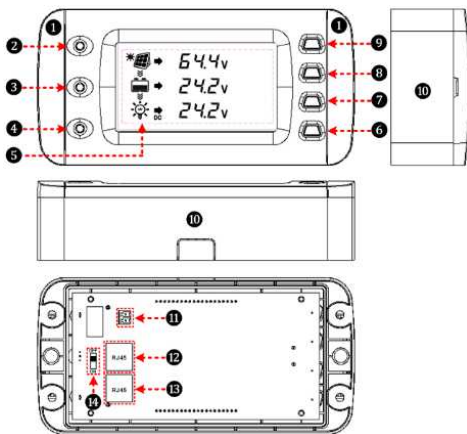

①	Decorative shell	⑧	Battery parameter button
②	PV indicator	⑨	PV parameter button
③	Battery indicator	⑩	Base (optional)
④	Load indicator	⑪	Dry contact interface ^①
⑤	LCD	⑫	RS485 port 1(RJ45)
⑥	Load ON/OFF button	⑬	RS485 port 2(RJ45)
⑦	Load parameter button	⑭	Dry contact enable switch ^①

① Working Principle:

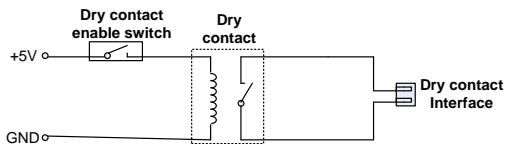

Dry contact rated value: 5A/30VDC; Max. value: 0.5A/60VDC

4. Accessories

Category	Name	Number/Model
Included Accessories	2P-3.81 plug	2 pcs
	RS485 cable	2 pcs/CC-RS485-RS485-200U
Optional Accessories	Base of MT75	1 pcs
	RS485 cable	CC-RS485-RS485-50/100/200/300/500/1000U (0.5/1/2/3/5/10 meter)
	Relay interface cable	C-2P3.81-2P3.81-50/100/200/300/500/1000U (0.5/1/2/3/5/10 meter)

5. Installation Instructions

● Before Installation

1. Check whether the ID of the solar controller is 1; if not, please set it to 1.
2. Check whether the ID of the inverter is 3; if not, please set it to 3.
3. Wall installation or surface mounting installation is optional.

● Wall Installation

Step 1: Locate and drill screw holes based on the frame mounting dimension (175x50mm), and erect the plastic expansion bolts.

Step 2: Use four M5 self-tapping screws to fix the frame.

Step 3: Remove the decorative shell.

Step 4: Use two M4 pan head screws to mount the MT75 surface on the base.

Step 5: Install the decorative shell.

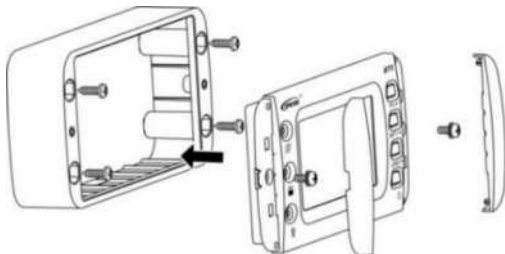

- **Surface Mounting Installation**

Step 1: Locate based on the installation size (176mm), and drill screw holes (no smaller than 158.2x85mm).



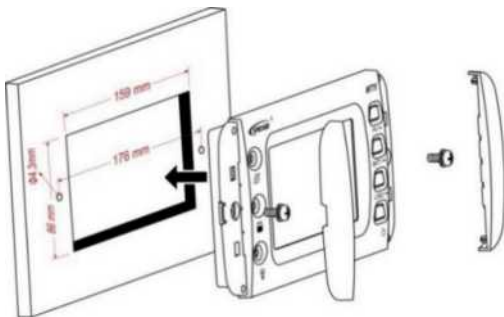

Step 2: Remove the decorative shell.

Step 3: Use two M4 pan head screws to fix MT75.





Step 4: Install the decorative shell.



6. Indicator Instruction

Indicator	Color	Status	Instruction
	Green	ON solid	PV is charging
	Green	OFF	No PV charge
	Green	Fast flashing	PV over voltage
	Green	ON solid	Battery normal
	Green	Fast flashing	Battery over voltage
	Orange	ON solid	Battery under voltage
	Red	ON solid	Battery over discharge
	Red	Slow flashing	Battery over temperature Battery under temperature Controller over temperature
	Green	ON solid	Load switch ON
	Green	OFF	Load switch OFF
	Green	Fast flashing	System voltage error
	Orange	Fast flashing	

7. Button Instruction









Button	Operation	Instruction
 PV / →	Click	Display PV parameters in cycle
 BATT / →	Click	Display battery parameter in cycle
 LOAD / →	Click	Display load parameter in cycle Exit the fault page
	Press for 5S	Check error code information
	Click	Control the switch of solar controller and inverter in sync ^①
	Press for 5S	Clear the total of PV generated power, total DC load usage, and total AC load usage

- ① When the output of the solar controller and inverter is out of sync, click to turn off all the loads' output at the same time, click again to turn on all the load outputs.





8. LCD Display













- LCD Display



Symbol	Definition	Symbol	Definition
	PV charging		PV no charge
			
	Load ON		Load OFF
			









- LCD Display Interface

Item	LCD Display	Definition
PV	 → 64.4v	PV voltage
	 → 3.3 A	PV current
	 → 0.2 kW	PV power
	 → 0.6 kWh	Total PV generated power
Battery	 → 24.0v	Battery voltage

	 → 11.1 A	Battery current
	 → 35.0 %	Battery capacity
	 → 25.0 °C	Battery temperature
DC Load	 → 25.3 V DC	DC load voltage
	 → 4.9 A DC	DC load current
	 → 0.1 kW DC	DC load power
	 → 0.1 kWh DC	Total DC load usage
AC Load	 → 219.9 V AC	AC load voltage
	 → 1.7 A AC	AC load current
	 → 0.3 kW AC	AC load power
	 → 0.3 kWh AC	Total AC load usage
	 → 50.0 Hz AC	AC load frequency

9. Error Codes

- Solar Controller Error Codes

Indicator	Color	Status	LCD	Code
	Green	Fast flashing	<i>Err</i> ▲ <i>1001</i>	Battery over voltage
	Orange	On solid	—	Battery under voltage
	Red	On solid	<i>Err</i> ▲ <i>1002</i>	Battery over discharge
	Red	Slow flashing	<i>Err</i> ▲ <i>1003</i>	Battery over temperature
			<i>Err</i> ▲ <i>1004</i>	Battery under temperature
			<i>Err</i> ▲ <i>1005</i>	Controller over temperature
	Orange	Fast flashing	<i>Err</i> ▲ <i>1006</i>	System voltage error
	Green	Fast flashing		
	Green	Fast flashing	<i>Err</i> ▲ <i>1007</i>	PV over voltage
	Green	Slow flashing	<i>Err</i> ▲ <i>1008</i>	Load short circuit
	Green	Slow flashing	<i>Err</i> ▲ <i>1009</i>	Over load

Note: When the battery voltage is equal to the low voltage disconnect voltage (LVD) point of the controller, the output of the controller and inverter will be turned off.

- Inverter Error Codes

Indicator	Color	Status	LCD	Code
	Green	Slow flashing	<i>Err</i> ▲ <i>3001</i>	Output short circuit
			<i>Err</i> ▲ <i>3002</i>	Output over load
			<i>Err</i> ▲ <i>3003</i>	Output voltage abnormal
			<i>Err</i> ▲ <i>3004</i>	Busbar over voltage
			<i>Err</i> ▲ <i>3005</i>	Input over voltage
			<i>Err</i> ▲ <i>3006</i>	Input under voltage
			<i>Err</i> ▲ <i>3007</i>	Input over current
			<i>Err</i> ▲ <i>3008</i>	Inverter over temperature

10. Specifications

Item	MT75	
Compatible products	Controller	XTRA-N series/TRIRON series/ Tracer-AN series/Tracer-BN series Note: required cables for the above products are shipped with T .
		iTracer-AD series/iTracer-ND series Note: required cables for the above products need additional purchase.
	Inverter	Power series(kw or above, suitable for application)/IPower-Plus series/ NPower series/SHI series
Voltage supply	5VDC	
Power supply methods	Solar controller communication port Inverter communication port	
LCD visual angle	12' clock	
LCD backlight	Yes	
Installation methods	Wall installation Surface mounting installation	

Self-consumption	14mA/5V(no backlight) 26mA/5V(backlight)
Working temperature	-20℃~+65℃
Storage temperature	-20℃~+80℃
Dimension	193×94.6×48mm (base) 193×85.2×23mm (no base)
Mounting size	175×50mm(base) 176mm(no base)
Mounting hole size	φ 5mm(base) φ4.3mm(no base)
Net Weight	0.29Kg(base) 0.22Kg(no base)

11. Dimension

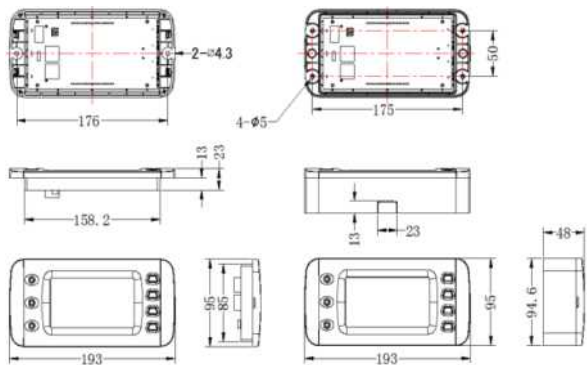

12. Recommended Applications

12.1 Standard Application

1) Advantages

MT75 monitors the operational status and error codes of the solar controller and inverter at the same time, also controls the AC load and DC load output by one button directly.

2) Connection Diagram

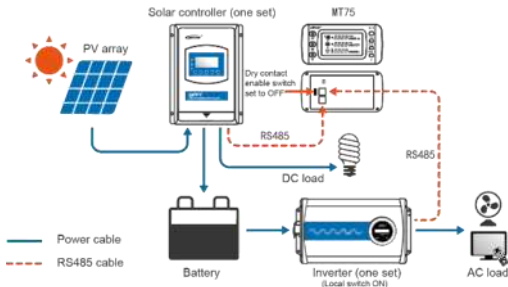

No.	Item	Number
1	Solar controller	1 pcs
2	Inverter	1 pcs
3	MT75	1 pcs
4	RS485 cable	2 pcs
5	PV, battery, AC load, DC load	According to actual needs

3) Operations

1. Connect the two communication ports of MT75 to solar controller and inverter.
2. Set MT75 dry contact enable switch to OFF state.
3. Must set inverter switch to ON state.
4. MT75 load ON/OFF button will directly control the AC and DC load output.

12.2 Upgrade Application

1) Advantages

MT75 monitors the operational status and error codes of the solar controller and inverter at the same time. The load ON/OFF button controls the inverter start or stop, which can effectively reduce the loss of the inverter and extend the lifetime of the system.

2) Connection Diagram

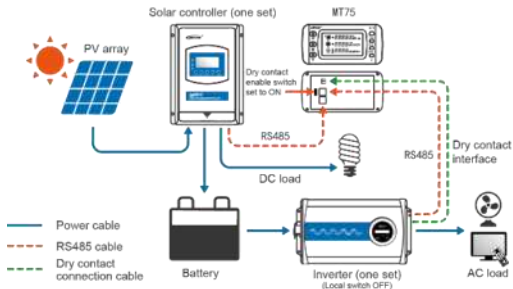

No.	Item	Number
1	Solar controller	1 pcs
2	Inverter	1 pcs

3	MT75	1 pcs
4	RS485 cable	2 pcs
5	Dry contact connection cable	1 pcs
6	PV, battery, AC load, DC load	According to actual needs

3) Operations

1. Connect the two communication ports of MT75 to solar controller and inverter.
2. Connect the dry contact interface of MT75 to the external switch port of the inverter.
3. Set MT75 dry contact enable switch to ON state.
4. Set inverter switch to OFF state.
5. MT75 load ON/OFF button controls the inverter start or stop remotely.

12.3 Advanced Application

1) Advantages

With the RS485-1M2S module, the MT75 not only can monitor the operational status of the solar controller and inverter, but it also can connect with external WIFI, Bluetooth module, or PC. The parameter settings and operational status monitoring can be collected by phone APP or PC software. MT75 can also control the output of AC and DC loads by one button in this application.

2) Connection Diagram

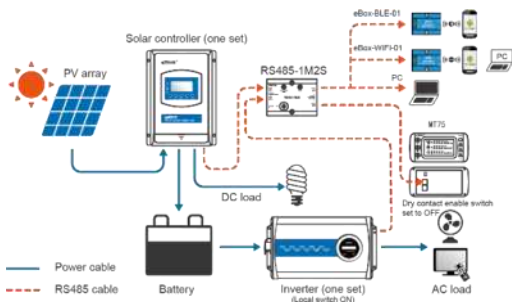

No.	Item	Number
1	Solar controller	1 pcs
2	Inverter	1 pcs
3	MT75	1 pcs
4	RS485-1M2S module	1 pcs
5	WIFI, BT module, or PC com. cable	1 pcs
6	Mobile phone or PC	1 pcs
7	RS485 cable	4 pcs
8	PV, battery, AC load, DC load	According to actual needs

3) Operations

1. Connect the main port of RS485-1M2S to solar controller and inverter.

2. Connect the slave port of RS485-1M2S to MT75 and WIFI/BT/PC com. cable.
3. Set MT75 dry contact enable switch to OFF state.
4. Must set inverter switch to ON state.
5. Set the parameters or monitor the operational status of the solar controller and inverter by phone APP or PC software.
6. MT75 load ON/OFF button will directly control the AC and DC load output.

12.4 Pro. Application

1) Advantages

With the RS485-1M2S module, the MT75 not only can monitor the operational status of the solar controller and inverter, but it also can connect with external WIFI, Bluetooth module, or PC. The parameter settings and operational status monitoring can be collected by phone APP or PC software. MT75 can also remotely control the inverter start or stop, which effectively prolongs the system's lifetime.

2) Connection Diagram

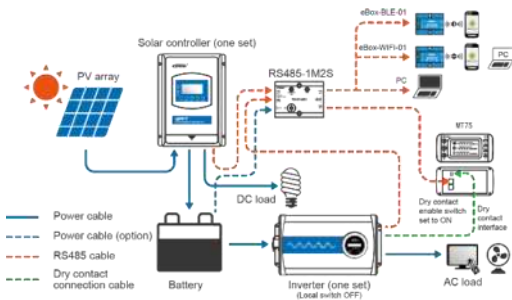

No.	Item	Number
1	Solar controller	1 pcs
2	Inverter	1 pcs
3	MT75	1 pcs
4	RS485-1M2S module	1 pcs
5	WIFI, BT module, or PC com. cable	1 pcs
6	Mobile phone or PC	1 pcs
7	RS485 cable	4 pcs
8	Dry contact connection cable	1 pcs
9	Power cable	1 pcs
10	PV, battery, AC load, DC load	According to actual needs

3) Operations

1. Connect the main port of RS485-1M2S to controller and inverter.
2. Connect the slave port of RS485-1M2S to MT75 and WIFI/BT/PC com. cable.
3. Connect the dry contact interface of MT75 to the external switch port of the inverter.
4. Set MT75 dry contact enable switch to ON state.
5. Set inverter switch to OFF state.
6. Set the parameters or monitor the operational status of the solar controller and inverter by phone APP or PC software.
7. MT75 load ON/OFF button controls inverter start or stop remotely.

HUIZHOU EPEVER TECHNOLOGY CO., LTD.

Beijing Tel: +86-10-82894896/82894112

Huizhou Tel: +86-752-3889706

E-mail: info@epsolarpv.com

Website: www.epsolarpv.com

www.epever.com